

Motor controllers CMMD-AS, for servo motors



Motor controllers CMMD-AS, for servo motors

Key features

Comparison of motor controllers				
Motor controller for motor type	CMMD-AS Servo motor	CMMS-AS Servo motor	CMMP-AS Servo motor	CMMS-ST Stepper motor
Positioning records	2x 63	63	255	63
Measuring system	Incremental/absolute		Incremental/absolute	Incremental
Extended I/O interface	4 working modes		Flexibly configurable	4 working modes
Notification of remaining distance	1 for n		Separately for all positions	1 for n
Torque reduction	No		Separately for all positions	No
Set linking	Linear		With branching	Linear
STO/SS1	To EN 61800-5-2		To EN 61800-5-2	To EN 61800-5-2

Performance characteristics

Compactness	Motion control
<ul style="list-style-type: none"> The double motor controller CMMD-AS consists of two identical motor controllers CMMS-AS in one housing Intermediate circuits are connected internally Braking resistors are connected in parallel internally so that twice the continuous braking performance is available Total nominal current is 8 A. The nominal current can be flexibly distributed between the axes 	<ul style="list-style-type: none"> Small dimensions Full integration of all components for controller and power section, including RS232 and CANopen interface Integrated brake chopper Integrated EMC filters Automatic actuation for a holding brake integrated in the motor Complies with the current CE and EN standards without additional external measures (motor cable length of up to 15 m)

Fieldbus interfaces

Integrated:	Optional:
	 

Input/output

- Freely programmable I/Os
- High-resolution 12-bit analogue input
- Jog/teach-in mode
- Easy linking to a higher-level controller via I/O or fieldbus
- Synchronous operation
- Master/slave mode
- Additional I/Os with the plug-in card CAMC-D-8E8A → 10

Integrated sequence control

- Automatic sequence of positioning records without a higher-level controller
- Linear and cyclical position sequences
- Adjustable delay times

Motor controllers CMMD-AS, for servo motors

Key features

Performance characteristics

Integrated safety functions

- The motor controller CMMD-AS support the "Safe Torque Off (STO)" and "Safe Stop 1 (SS1)" safety functions with protection against unexpected start-up in accordance with EN 61800-5-2
- Protection against unexpected start-up

- Two-channel disconnection of the output stage
- Reduced external circuitry
- Shorter response times in the event of an error
- Faster restart, intermediate circuit remains charged

Interpolating multi-axis movement

- With a suitable controller, the CMMD-AS can perform path movements with interpolation via CAN-open. The controller specifies setpoint position values in a fixed

time pattern to this end. In between, the servo position controller independently interpolates the data values between two data points.

Travel program

- Linking of any number of positioning records into a travel program
- Step criteria for the travel program possible via digital inputs, for example
MC – motion complete
I/O – digital inputs

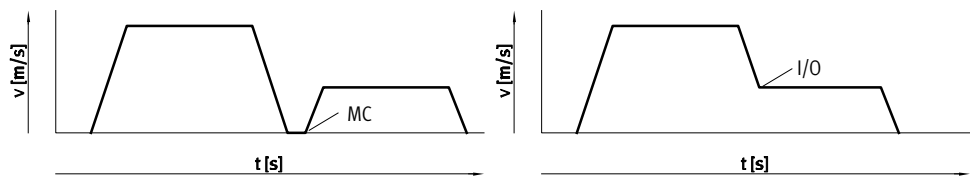

Library for EPLAN



EPLAN macros for fast and reliable planning of electrical projects in combination with motor controllers,

motors and cables. This enables a high level of planning reliability, standardisation of

documentation, no need to create symbols, graphics and master data.

Motor controllers CMMD-AS, for servo motors

Key features

FCT software – Festo Configuration Tool

Software platform for electric drives from Festo

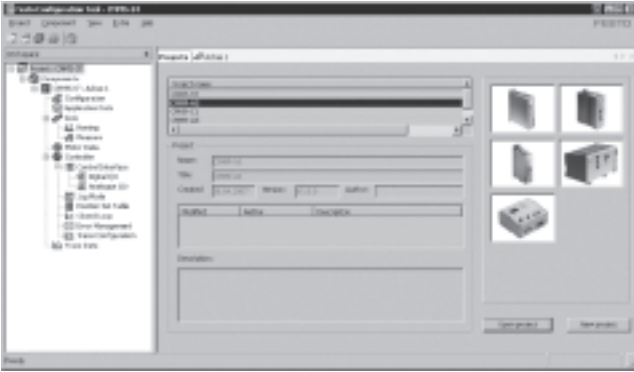

- All drives in a system can be managed and saved in a common project
- Project and data management for all supported device types
- Easy to use thanks to graphically supported parameter entry
- Universal mode of operation for all drives
- Working offline at your desk or online at the machine

FHPP – Festo Handling and Positioning Profile

Optimised data profile

Festo has developed an optimised data profile especially tailored to the target applications for handling and positioning tasks, the "Festo Handling and Positioning Profile (FHPP)".

The FHPP data profile permits the actuation of Festo motor controllers, using a fieldbus interface, via standardised control and status bytes.

The following are defined, among others:

- Operating modes
- I/O data structure
- Parameter objects
- Sequence control

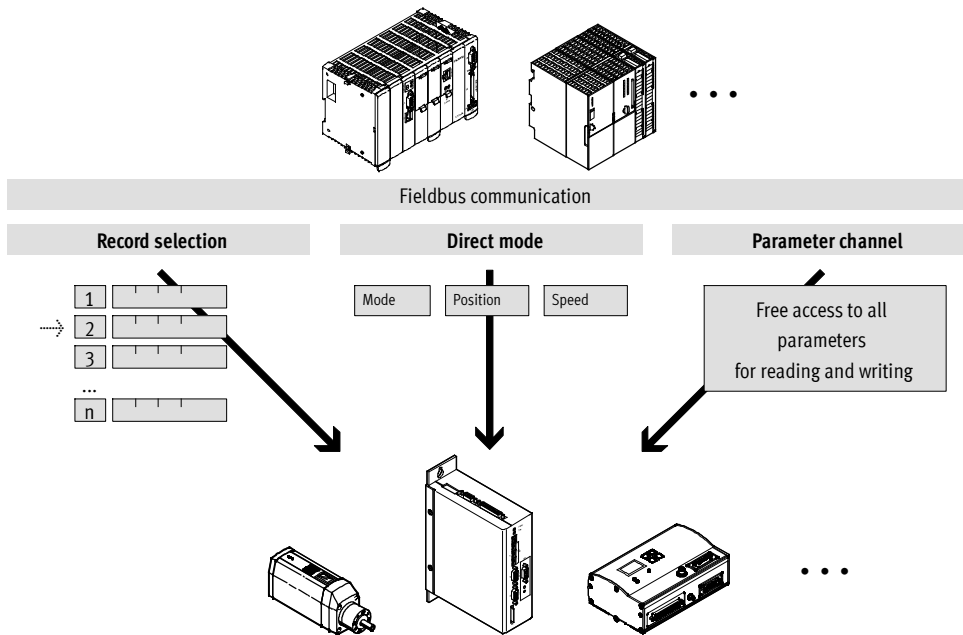

Motor controllers CMMD-AS, for servo motors

Type codes

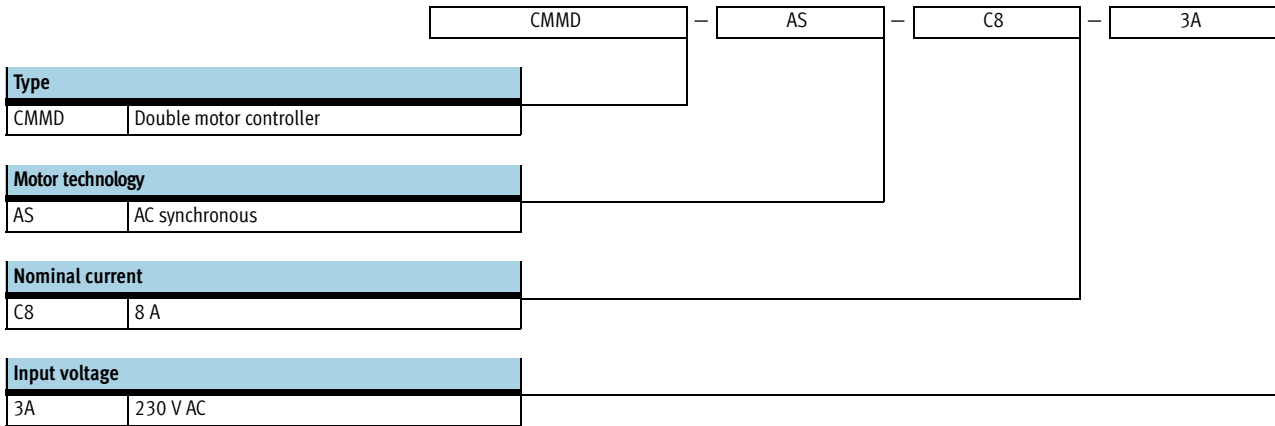

Motor controllers CMMD-AS, for servo motors

Technical data

Fieldbus interfaces



General technical data		
Type of mounting		Screwed to a mounting plate
Display		7-segment display
Parameterisation interface		RS232 (9,600 ... 115,000 bits/s)
Encoder interface input		Setpoint position value as encoder signal EnDat V2.2
Encoder interface output		Actual value feedback via encoder signals in speed control mode Setpoint specification for downstream slave drive Resolution 4,096 ppr
Braking resistor, integrated	[Ω]	115
Pulse power of braking resistor	[kVA]	1.4
Braking resistor, external	[Ω]	50
Impedance of setpoint input	[kΩ]	20
Number of analogue outputs		2
Operating range of analogue outputs	[V]	0 ... 10
Resolution of analogue outputs	[bit]	8
Characteristics of analogue outputs		Short circuit proof
Number of analogue inputs		2
Operating range of analogue inputs	[V]	±10
Characteristics of analogue inputs		Differential inputs Configurable for speed Configurable for current
Mains filter		Integrated
Max. length of motor cable	[m]	15 (without external mains filter)
Product weight	[g]	2,400

Technical data – Fieldbus interface					
Interfaces	I/O	CANopen	Profibus DP	DeviceNet	
Number of digital logic outputs		10			
Characteristics of digital logic outputs		Freely configurable in some cases			
Number of digital logic inputs		28	–		
Operating range of logic inputs	[V]	12 ... 30	–		
Characteristics of logic inputs		Freely configurable	–		
Process coupling		For 2x 63 positioning records	For 2x 63 positioning records		
Communication profile		–	DS301, FHPP	DP-V0/FHPP	FHPP
		–	DS301, DSP402	–	
Max. fieldbus transmission rate	[Mbps]	–	1	12	0.5
Interface	Integrated	■	■	–	–
	Optional	–	–	■	■
				→ 11	→ 11

Motor controllers CMMD-AS, for servo motors

Technical data

Function blocks for PLC programming				
Programming software	Controller manufacturer	Interfaces		
		CANopen	Profibus DP	DeviceNet
CoDeSys	Festo			
	Beckhoff	■	■	■
	Other manufacturers			
RSLogix5000	Rockwell Automation	-	-	■
Step 7	Siemens	-	■	-

Electrical data		
Output port data		
Output voltage range	[V AC]	0 V to the input voltage
Nominal output current	[A]	8
Peak current	[A]	20
Max. peak current duration	[s]	2
Max. intermediate circuit voltage	[V DC]	380
Output frequency	[Hz]	0 1,000
Load supply		
Nominal voltage phases		1
Input voltage range	[V AC]	95 ... 255
Max. nominal input current	[A]	10
Rated output	[VA]	1,200
Peak output	[VA]	2,400
Mains frequency	[Hz]	50 ... 60
Logic supply		
Nominal voltage	[V DC]	24 ±20%
Nominal current	[A]	0.7
Peak current (incl. holding brake)	[A]	3.6
Max. current of digital logic outputs	[mA]	100

Operating and environmental conditions	
Digital logic outputs	Not galvanically isolated
Logic inputs	Galvanically connected to logic potential
Protection class	IP20
Protective function	I ² t monitoring
	Intermediate circuit over/undervoltage
	Short circuit in output stage
	Standstill monitoring
	Temperature monitoring
Ambient temperature	[°C] 0 ... +50
Storage temperature	[°C] -25 ... +70
Relative air humidity	[%] 0 ... 90 (non-condensing)
CE mark (see declaration of conformity)	To EU Low Voltage Directive
	To EU EMC Directive ¹⁾
	To EU Machinery Directive
Certification	c UL - Recognized (OL)
	UL - Listed (OL)
	C-Tick
	BIA
Certificate issuing authority	BG MFS 10009
Safety function	Safe Torque off (STO)
Safety Integrity Level (SIL)	Safe Torque off (STO) / SIL 2
Performance Level (PL)	Safe Torque off (STO) / category 3, performance level d
Note on materials	RoHS-compliant

1) For information about the applicability of the component see the manufacturer's EC declaration of conformity at: www.festo.com → Support → User documentation.
If the component is subject to restrictions on usage in residential, office or commercial environments or small businesses, further measures to reduce the emitted interference may be necessary.

CoDeSys®, Rockwell Automation® is a registered trademark of its respective trademark holder in certain countries.

Motor controllers CMMD-AS, for servo motors

Technical data

View of motor controller

From the front

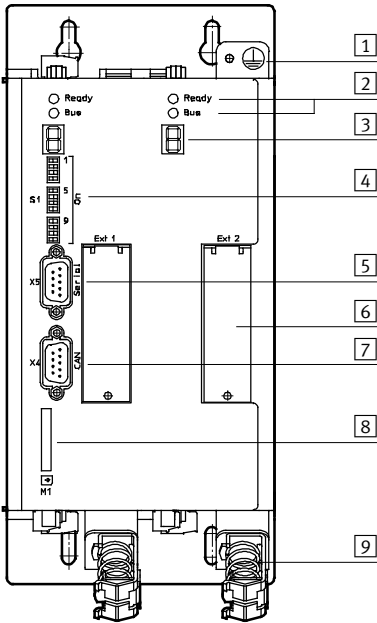

- 1 Earthing
- 2 Ready/bus LED
- 3 Status displays
- 4 Fieldbus settings and boot loader
- 5 Interface: RS232/RS485
- 6 Technology modules (optional)
- 7 Interface: CAN bus
- 8 SD memory card
- 9 Screened connections

From above

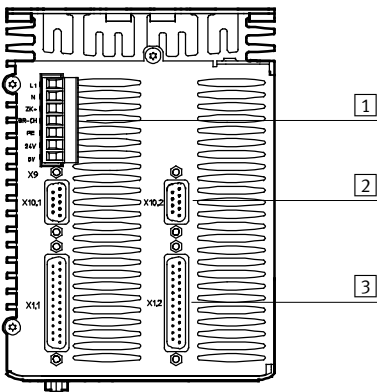

- 1 Power supply
- 2 Incremental encoder interface (bidirectional)
- 3 I/O interface

From underneath

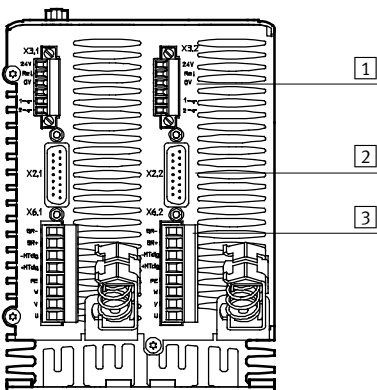

- 1 Safe stop
- 2 Encoder connection
- 3 Motor connection

Motor controllers CMMD-AS, for servo motors

Technical data

FESTO

Installation clearance for motor controller

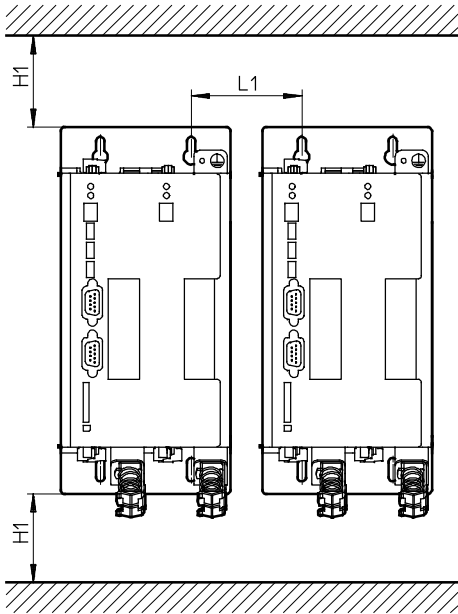

H1	L1
100	73

Dimensions

Download CAD data → www.festo.com

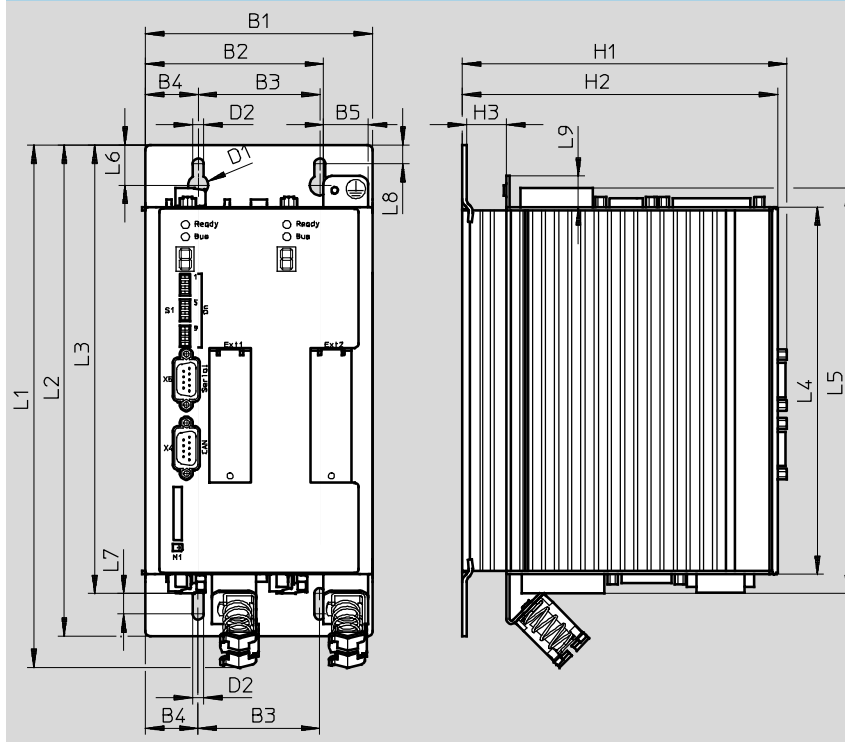

Type	B1	B2	B3	B4	B5	D1	D2	H1	H2	H3
CMMD-AS	112	87.8	60	26	22	10	5.5	160	155.5	19.7

Type	L1	L2	L3	L4	L5	L6	L7	L8	L9
CMMD-AS	257.6	242.1	221.1	181	200	19.75	10	9.25	15.3

Motor controllers CMMD-AS, for servo motors

Technical data and accessories

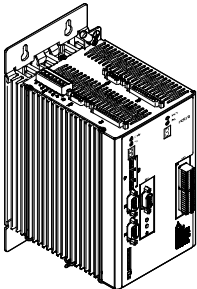
Ordering data			
	Brief description	Part No.	Type
	The plug assortment NEKM (→ 11) and the operator package (→ 12) are included in the scope of delivery.	561406	CMMD-AS-C8-3A

Accessories

Interface CAMC-D-8E8A

The interface is used to extend the digital I/Os.

Up to two interfaces are supported simultaneously.



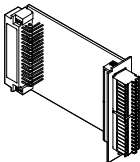

Technical data		
General information		
Max. cable cross section	[mm ²]	0.5
Digital inputs		
Number		8
Nominal voltage	[V DC]	24
Voltage range	[V]	-30 ... +30 (protected against reverse polarity and short circuit proof)
Nominal value for True	[V]	8
Nominal value for False	[V]	2
Input impedance	[kΩ]	4.7
Digital outputs		
Number		8
Nominal voltage	[V DC]	24
Voltage range	[V]	+18 ... +30 (protected against reverse polarity and short circuit proof, protection in the event of thermal overload)
Output current	[mA]	100
Short circuit, overcurrent protection	[mA]	500

Ordering data – Plug-in card			
	Brief description	Part No.	Type
	For additional I/Os (The plugs are included in the scope of delivery. Plug NEKM for reorder → 11)	567855	CAMC-D-8E8A

Motor controllers CMMD-AS, for servo motors

FESTO

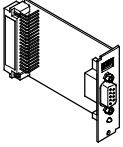
Accessories

Ordering data – Plug-in cards			
	Brief description	Part No.	Type
	Interface module, for Profibus interface	547450	CAMC-PB
	Interface module, for DeviceNet interface	547451	CAMC-DN
	Memory card, for data backup and firmware downloads	562212	CAMC-M-S-F3-V1

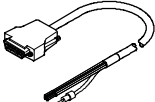
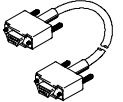
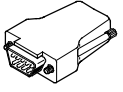
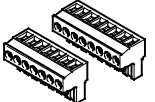
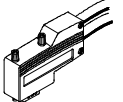
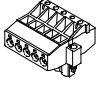
Ordering data – Cables and plugs				
	Brief description	Cable length [m]	Part No.	Type
	Control cable, for I/O interface to any controller	2.5	552254	NEBC-S1G25-K-2.5N-LE26
	Programming cable	1.5	160786	PS1-ZK11-NULLMODEM-1,5M
	Encoder plug, for incremental encoder interface	–	564264	NECC-A-S-S1G9-C2M
	Plug assortment for CMMD	–	560504	NEKM-C-4 ¹⁾
	Plug assortment for interface CAMC-D-8E8A	–	569959	NEKM-C-5 ²⁾
	Plug for Profibus interface	–	533780	FBS-SUB-9-WS-PB-K
	Plug for CANopen interface	–	533783	FBS-SUB-9-WS-CO-K
	Plug for DeviceNet interface	–	525635	FBSD-KL-2X5POL

1) Comprising plug for power supply and plug for motor connection. The plug assortment is included in the scope of delivery of the motor controller.

2) Plugs are included in the scope of delivery of the interface card CAMC-D-8E8A.

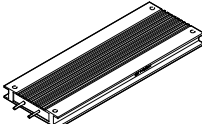
Ordering data – Braking resistances				
	Resistance value [Ω]	Nominal power [W]	Part No.	Type
	72	500	1336611	CACR-LE2-72-W500

Motor controllers CMMD-AS, for servo motors

Accessories

Ordering data – Software and documentation			
	Brief description	Part No.	Type
	Operator package contains: – CD-ROM – with manual for CMMD-AS, in de, en, es, fr, it, sv – with FCT (Festo Configuration Tool) configuration software, in de, en – Brief description This package is included in the scope of delivery	570608	GSIB-CMMD-AS-ML

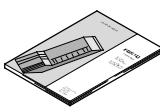
Ordering data – Documentation ¹⁾					
	Language	Part No. Type		Part No. Type	
		For motor controller		Festo Handling and Positioning Profile (FHPP) for the motor controller range CMM...	
	DE	571733	P.BE-CMMD-AS-3A-HW-DE	555695	P.BE-CMM-FHPP-SW-DE
	EN	571734	P.BE-CMMD-AS-3A-HW-EN	555696	P.BE-CMM-FHPP-SW-EN
	ES	571735	P.BE-CMMD-AS-3A-HW-ES	555697	P.BE-CMM-FHPP-SW-ES
	FR	571736	P.BE-CMMD-AS-3A-HW-FR	555698	P.BE-CMM-FHPP-SW-FR
	IT	571737	P.BE-CMMD-AS-3A-HW-IT	555699	P.BE-CMM-FHPP-SW-IT
	SV	571738	P.BE-CMMD-AS-3A-HW-SV	555700	P.BE-CMM-FHPP-SW-SV
		For CANopen interface		For Profibus interface	
	DE	554351	P.BE-CMMS-FHPP-CO-SW-DE	554345	P.BE-CMMS-FHPP-PB-SW-DE
	EN	554352	P.BE-CMMS-FHPP-CO-SW-EN	554346	P.BE-CMMS-FHPP-PB-SW-EN
	ES	554353	P.BE-CMMS-FHPP-CO-SW-ES	554347	P.BE-CMMS-FHPP-PB-SW-ES
	FR	554354	P.BE-CMMS-FHPP-CO-SW-FR	554348	P.BE-CMMS-FHPP-PB-SW-FR
	IT	554355	P.BE-CMMS-FHPP-CO-SW-IT	554349	P.BE-CMMS-FHPP-PB-SW-IT
	SV	554356	P.BE-CMMS-FHPP-CO-SW-SV	554350	P.BE-CMMS-FHPP-PB-SW-SV
		For DeviceNet interface			
DE	554357	P.BE-CMMS-FHPP-DN-SW-DE			
EN	554358	P.BE-CMMS-FHPP-DN-SW-EN			
ES	554359	P.BE-CMMS-FHPP-DN-SW-ES			
FR	554360	P.BE-CMMS-FHPP-DN-SW-FR			
IT	554361	P.BE-CMMS-FHPP-DN-SW-IT			
SV	554362	P.BE-CMMS-FHPP-DN-SW-SV			

1) Manual in paper form is not included in the scope of delivery